

UNIT 2: Natural Resources

2.1 INTRODUCTION	16
2.2 RENEWABLE AND NON-RENEWABLE RESOURCES	20
2.2.1 Natural resources and associated problems	20
2.2.2 Non-renewable resources	22
2.2.3 Renewable resources	22
a. Forest Resources: Use and over-exploitation, deforestation, case studies. Timber extraction, mining, dams and their effects on forests and tribal people	23
b. Water Resources: Use and over-utilisation of surface and ground water, floods, drought, conflicts over water, dams – benefits and problems.	26
c. Mineral Resources: Use and exploitation, environmental effects of extracting and using mineral resources, case studies.	30
d. Food Resources: World food problems, Changes in landuse by agriculture and grazing, Effects of modern agriculture, Fertilizer/ pesticide problems, Water logging and salinity	32
e. Energy Resources: Increasing energy needs, Renewable/ non renewable, Use of Alternate energy sources, Case studies	35
f. Land resources: Land as a resource, land degradation, man-induced land-slides, soil erosion and desertification.	48
2.3 ROLE OF AN INDIVIDUAL IN CONSERVATION OF NATURAL RESOURCES	50
2.4 EQUITABLE USE OF RESOURCES FOR SUSTAINABLE LIFESTYLES	51
<i>Natural Resources</i>	15

2.1 INTRODUCTION

Our environment provides us with a variety of goods and services necessary for our day to day lives. These **natural resources** include, air, water, soil, minerals, along with the climate and solar energy, which form the non-living or '**abiotic**' part of nature. The '**biotic**' or living parts of nature consists of **plants and animals**, including **microbes**. Plants and animals can only survive as communities of different organisms, all closely linked to each in their own **habitat**, and requiring specific abiotic conditions. Thus, forests, grasslands, deserts, mountains, rivers, lakes and the marine environment all form habitats for specialised communities of plants and animals to live in. **Interactions between the abiotic aspects of nature and specific living organisms together form ecosystems** of various types. Many of these living organisms are used as our **food resources**. Others are linked to our food less directly, such as **pollinators** and **dispersers** of plants, soil animals like **worms**, which **recycle nutrients** for plant growth, and **fungi** and **termites** that break up **dead plant material** so that micro-organisms can act on the detritus to reform soil nutrients.

History of our global environment: About ten thousand years ago, when mankind changed from a hunter-gatherer, living in wilderness areas such as forests and grasslands, into an **agriculturalist** and **pastoralist**, we began to change the environment to suit our own requirements. As our ability to grow food and use domestic animals grew, these '**natural**' ecosystems were developed into agricultural land. Most traditional agriculturists depended extensively on **rain**, **streams** and **rivers** for water. Later they began to use wells to tap **underground water** sources and to impound water and created irrigated land by building **dams**. Recently we began to use **fertilizers** and **pesticides** to further boost the production of food from the same amount of land. However we now realize that all this has led to several undesirable changes in our environment. **Mankind has been overusing and depleting natural resources**. The over-intensive use of land has been found to exhaust the capability of the ecosystem to support the growing demands of more and more people, all requiring more intensive use of resources. Industrial growth, urbanisation, population growth and the enormous increase in the use of consumer goods, have all put further stresses on the environment. They create great quantities of **solid waste**. **Pollution of air, water and soil have begun to seriously affect human health.**

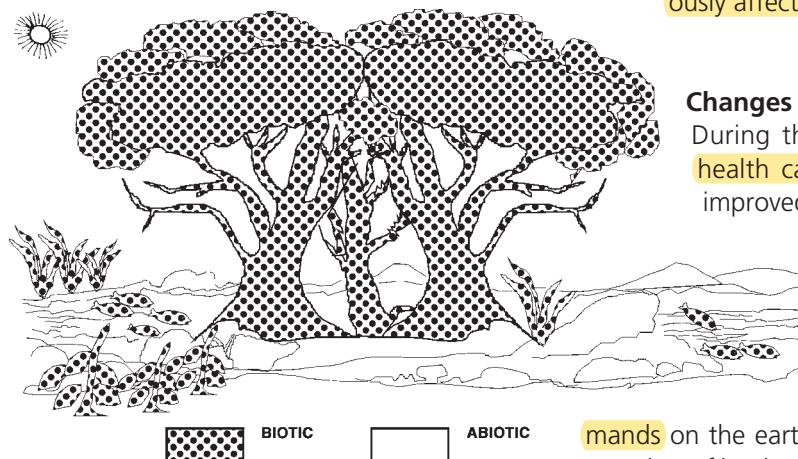

Changes in land and resource use:

During the last 100 years, a better **health care** delivery system and an improved **nutritional status** has led to rapid **population growth**, especially in the developing countries. This phenomenal rise in human numbers has, in the recent past, placed **great demands** on the earth's **natural resources**. Large stretches of land such as forests, grasslands and wetlands have been converted into intensive agriculture. Land has been taken for industry and

the urban sectors. These changes have brought about dramatic alterations in land-use patterns and rapid disappearance of valuable natural ecosystems. The need for more water, more food, more energy, more consumer goods, is not only the result of a greater population, but also the result of over-utilization of resources by people from the more affluent societies, and the affluent sections of our own.

Industrial development is aimed at meeting growing demands for all consumer items. However, these consumer goods also generate waste in ever larger quantities. The growth of industrial complexes has led to a shift of people from their traditional, sustainable, rural way of life to urban centers that developed around industry. During the last few decades, several small urban centers have become large cities, some have even become giant mega-cities. This has increased the disparity between what the surrounding land can produce and what the large number of increasingly consumer-oriented people in these areas of high population density consume. Urban centers cannot exist without resources such as water from rivers and lakes, food from agricultural areas, domestic animals from pasture lands and timber, fuel wood, construction material and other resources from forests. Rural agricultural systems are dependent on forests, wetlands, grasslands, rivers and lakes. The result is a movement of natural resources from the wilderness ecosystems and agricultural sector to the urban user. The magnitude of the shift of resources has been increasing in parallel with the growth of industry and urbanisation, and has changed natural landscapes all over the world. In many cases, this has led to the rapid development of the urban economy, but to a far slower economic development for rural people and serious impoverishment of the lives of wilderness dwellers. The result is a serious inequality in the distribution of resources among human beings, which is both unfair and unsustainable.

Natural Resources

Earth's Resources and Man: The resources on which mankind is dependent are provided by various sources or 'spheres'.

1) Atmosphere

- Oxygen for human respiration (metabolic requirements).
- Oxygen for wild fauna in natural ecosystems and domestic animals used by man as food.
- Oxygen as a part of carbon dioxide, used for the growth of plants (in turn are used by man).

The atmosphere forms a protective shell over the earth. The lowest layer, the troposphere, the only part warm enough for us to survive in, is only 12 kilometers thick. The stratosphere is 50 kilometers thick and contains a layer of sulphates which is important for the formation of rain. It also contains a layer of ozone, which absorbs ultra-violet light known to cause cancer and without which, no life could exist on earth. The atmosphere is not uniformly warmed by the sun. This leads to air flows and variations in climate, temperature and rainfall in different parts of the earth. It is a complex dynamic system. If its nature is disrupted it affects all mankind. Most air pollutants have both global and regional effects.

Living creatures cannot survive without air even for a span of a few minutes. To continue to support life, air must be kept clean. Major pollutants of air are created by industrial units that release various gases such as carbon dioxide, carbon monoxide and toxic fumes into the air. Air is also polluted by burning fossil fuels. The buildup of carbon dioxide which is known as 'greenhouse effect' in the atmosphere is leading to current global warming. The growing number of scooters, motorcycles, cars, buses and trucks which run on fossil fuel (petrol and diesel) is a major cause of air pollution in cities and along highways.

Air pollution leads to acute and chronic respiratory diseases such as various lung infections, asthma and even cancer.

2) Hydrosphere

- Clean water for **drinking** (a metabolic requirement for living processes).
- Water for **washing and cooking**.
- Water used in **agriculture and industry**.
- **Food resources from the sea**, including fish, crustacea, sea weed, etc.
- Food from fresh water sources, including fish, crustacea and aquatic plants.
- Water flowing down from mountain ranges harnessed to generate **electricity** in hydroelectric projects.

The hydrosphere covers three quarters of the earth's surface. A major part of the hydrosphere is the **marine ecosystem** in the ocean, while only a small part occurs in fresh water. Fresh water in rivers, lakes and glaciers, is perpetually being renewed by a process of evaporation and rainfall. Some of this fresh water lies in underground aquifers. **Human activities such as deforestation create serious changes in the hydrosphere. Once land is denuded of vegetation, the rain erodes the soil which is washed into the sea.**

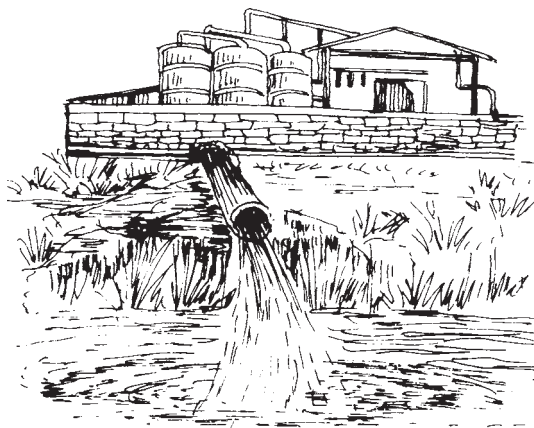

18

Chemicals from industry and sewage find their way into rivers and into the sea. **Water pollution thus threatens the health** of communities as all our lives depend on the availability of clean water. **This once plentiful resource is now becoming rare and expensive due to pollution.**

3) Lithosphere

- **Soil, the basis for agriculture** to provide us with food.
- Stone, sand and gravel, used for **construction**.
- **Micronutrients** in soil, essential for plant growth.
- **Microscopic flora**, small soil fauna and fungi in soil, important living organisms of the lithosphere, which **break down plant litter** as well as animal wastes to provide nutrients for plants.
- A large number of **minerals** on which our industries are based.
- Oil, coal and gas, extracted from underground sources. It provides power for vehicles, agricultural machinery, industry, and for our homes.

The lithosphere began as a hot ball of matter which formed the earth about **4.6 billion years ago**. About **3.2 billion years ago**, the earth cooled down considerably and a very special event took place - **life began** on our planet. The crust of the earth is 6 or 7 kilometers thick and lies under the continents. Of the 92 elements in the lithosphere only eight are common constituents of crustal rocks. Of these constituents, 47% is oxygen, 28% is silicon, 8% is aluminium, 5% is iron, while sodium, magnesium, potassium and calcium constitute 4% each. Together, these elements form about 200 common mineral compounds. **Rocks, when broken down, form soil on which man is dependent for his agriculture.** Their minerals are also the raw material used in various industries.

Environmental Studies for Undergraduate Courses

4) Biosphere

- Food, from crops and domestic animals, providing human metabolic requirements.
- Food, for all forms of life which live as interdependent species in a community and form food chains in nature on which man is dependent.
- Energy needs: Biomass fuel wood collected from forests and plantations, along with other forms of organic matter, used as a source of energy.
- Timber and other construction materials.

This is the relatively thin layer on the earth in which life can exist. Within it the air, water, rocks and soil and the living creatures, form structural and functional ecological units, which together can be considered as one giant global living system, that of our Earth itself. Within this framework, those characterised by broadly similar geography and climate, as well as communities of plant and animal life can be divided for convenience into different biogeographical realms. These occur on different continents. Within these, smaller biogeographical units can be identified on the basis of structural differences and functional aspects into distinctive recognizable ecosystems, which give a distinctive character to a landscape or waterscape. Their easily visible and identifiable characteristics can be described at different scales such as those of a country, a state, a district or even an individual valley, hill range, river or lake.

The simplest of these ecosystems to understand is a pond. It can be used as a model to understand the nature of any other ecosystem and to appreciate the changes over time that are seen in any ecosystem. The structural features of a pond include its size, depth and the quality of its water. The periphery, the shallow part and the deep part of the pond, each provide specific conditions for different plant and animal communities. Functionally, a variety of cycles

such as the amount of water within the pond at different times of the year, the quantity of nutrients flowing into the pond from the surrounding terrestrial ecosystem, all affect the 'nature' of the pond.

Natural cycles between the spheres: All four spheres are closely inter-linked systems and are dependent on the integrity of each other. Disturbing one of these spheres in our environment affects all the others.

The linkages between them are mainly in the form of cycles. For instance, the atmosphere, hydrosphere and lithosphere are all connected through the **hydrological cycle**. Water evaporated from the hydrosphere (the seas and freshwater ecosystems), forms clouds in the atmosphere. This becomes rain, which provides moisture for the lithosphere, on which life depends. The rain also acts on rocks as an agent of erosion and over millions of years has created soil, on which plant life grows. Atmospheric movements in the form of wind, break down rocks into soil. The most sensitive and complex linkages are those between the atmosphere, the hydrosphere and the lithosphere on the one hand, with the millions of living organisms in the biosphere on the other. All living organisms which exist on earth live only in the relatively thin layer of the lithosphere and hydrosphere that is present on the surface of land and in the water. The biosphere which they form has countless associations with different parts of the three other 'spheres'.

It is therefore essential to understand the inter-relationships of the separate entities soil, water, air and living organisms, and to appreciate the value of preserving intact ecosystems as a whole.

Activity 1:

Observe a nearby pond in different seasons and document the seasonal changes in it. One can also observe changes in a river or the seasonal changes in a forest or grassland.

Activity 2:

Take a simple object in daily use and track its components back to each of its spheres.

Eg: this textbook: paper from wood – biosphere

Water for pulping – hydrosphere

Bleach to whiten paper – a mineral from lithosphere

2.2 RENEWABLE AND NON-RENEWABLE RESOURCES

Ecosystems act as resource producers and processors. Solar energy is the main driving force of ecological systems, providing energy for the growth of plants in forests, grasslands and aquatic ecosystems. A forest recycles its plant material slowly by continuously returning its dead material, leaves, branches, etc. to the soil. Grasslands recycle material much faster than forests as the grass dries up after the rains are over every year. All the aquatic ecosystems are also solar energy dependent and have cycles of growth when plant life spreads and aquatic animals breed. The sun also drives the water cycle.

Our food comes from both natural and agricultural ecosystems. Traditional agricultural ecosystems that depended on rainfall have been modified in recent times to produce more and more food by the addition of extra chemicals and

water from irrigation systems but are still dependent on solar energy for the growth of crops. Moreover modern agriculture creates a variety of environmental problems, which ultimately lead to the formation of unproductive land. These include irrigation, which leads to the development of saline soil, and the use of artificial fertilizers eventually ruin soil quality, and pesticides, which are a health hazard for humans as well as destroying components vital to the long-term health of agricultural ecosystems.

To manufacture consumer products, industry requires raw materials from nature, including water, minerals and power. During the manufacturing process, the gases, chemicals and waste products pollute our environment, unless the industry is carefully managed to clean up this mess.

2.2.1 Natural resources and associated problems

The unequal consumption of natural resources: A major part of natural resources are today consumed in the technologically advanced or 'developed' world, usually termed 'the North'. The 'developing nations' of 'the South', including India and China, also over use many resources because of their greater human population. However, the consumption of resources per capita (per individual) of the developed countries is up to 50 times greater than in most developing countries. Advanced countries produce over 75% of global industrial waste and greenhouse gases.

Energy from fossil fuels is consumed in relatively much greater quantities in developed countries. Their per capita consumption of food too is much greater as well as their waste of enormous quantities of food and other products, such as packaging material, used in the food industry. The USA for example with just 4% of

the world's population consumes about 25% of the world's resources.

Producing animal food for human consumption requires more land than growing crops. Thus countries that are highly dependent on non-vegetarian diets need much larger areas for pastureland than those where the people are mainly vegetarian.

Planning Landuse: Land itself is a major resource, needed for food production, animal husbandry, industry, and for our growing human settlements. These forms of intensive landuse are frequently extended at the cost of 'wild lands', our remaining forests, grasslands, wetlands and deserts. Thus it is essential to evolve a rational land-use policy that examines how much land must be made available for different purposes and where it must be situated. For instance, there are usually alternate sites at which industrial complexes or dams can be built, but a natural wilderness cannot be recreated artificially. Scientists today believe that at least 10 percent of land and water bodies of each ecosystem must be kept as wilderness for the long-term needs of protecting nature and natural resources.

Land as a resource is now under serious pressure due to an increasing 'land hunger' - to produce sufficient quantities of food for an exploding human population. It is also affected by degradation due to misuse. Land and water resources are polluted by industrial waste and rural and urban sewage. They are increasingly being diverted for short-term economic gains to agriculture and industry. Natural wetlands of great value are being drained for agriculture and other purposes. Semi-arid land is being irrigated and overused.

The most damaging change in landuse is demonstrated by the rapidity with which forests have vanished during recent times, both in India and in the rest of the world. Forests provide us with a variety of services. These include processes such as maintaining oxygen levels in the atmosphere, removal of carbon dioxide, control over water regimes, and slowing down erosion and also produce products such as food, fuel, timber, fodder, medicinal plants, etc. In the long term, the loss of these is far greater than the short-term gains produced by converting forested lands to other uses.



The need for sustainable lifestyles: The quality of human life and the quality of ecosystems on earth are indicators of the sustainable use of resources. There are clear indicators of sustainable lifestyles in human life.

- Increased longevity
- An increase in knowledge
- An enhancement of income.

These three together are known as the '**Human development index**'.

The quality of the ecosystems have indicators that are more difficult to assess.

- A stabilized population.
- The long term conservation of biodiversity.
- The careful long-term use of natural resources.
- The prevention of degradation and pollution of the environment.

2.2.2 Non-renewable resources

These are minerals that have been formed in the lithosphere over millions of years and constitute a closed system. These non-renewable resources, once used, remain on earth in a different form and, unless recycled, become waste material.

Non-renewable resources include fossil fuels such as oil and coal, which if extracted at the present rate, will soon be totally used up. The end products of fossil fuels are in the form of heat and mechanical energy and chemical compounds, which cannot be reconstituted as a resource.

2.2.3 Renewable resources

Though water and biological living resources are considered renewable. They are in fact renewable only within certain limits. They are linked to natural cycles such as the water cycle.

- Fresh water (even after being used) is evaporated by the sun's energy, forms water vapour and is reformed in clouds and falls to earth as rain. However, water sources can be overused or wasted to such an extent that they locally run dry. Water sources can be so heavily polluted by sewage and toxic substances that it becomes impossible to use the water.
- Forests, once destroyed take thousands of years to regrow into fully developed natural ecosystems with their full complement of species. Forests thus can be said to behave like non-renewable resources if overused.
- Fish are today being over-harvested until the catch has become a fraction of the original resource and the fish are incapable of breeding successfully to replenish the population.
- The output of agricultural land if mismanaged drops drastically.
- When the population of a species of plant or animal is reduced by human activities, until it cannot reproduce fast enough to maintain a viable number, the species becomes extinct.
- Many species are probably becoming extinct without us even knowing, and other linked species are affected by their loss.

The Dodo of Madagascar and the Cheetah in India are well known examples of extinct species. What is however not generally recognized is that thousands of extinctions of small plants and animals are occurring every year due to loss of their habitat. Over harvesting and poaching threaten the existence of many others.

Activity 3: Utilisation of resources

The use of a resource begins with its collection, its processing into a useable product, and transport through a delivery system, to the consumer who uses it. It also involves disposal of the waste products produced at each step. Each step in resource use can affect the environment for better or worse. The control of these steps is known as environmental management.

Think of a resource you use and track it through these steps.

Eg. The cotton in the clothes you are wearing. At each step note:

- **What other resources are needed at this step to move the resource you chose to the next?**
- **What waste products are generated at that step?**
- **How are they likely to be disposed off?**
- **What pollutants are generated in the process?**

a) Forest Resources

Use and overexploitation: Scientists estimate that India should ideally have 33 percent of its land under forests. Today we have only about 12 percent. Thus we need not only to protect existing forests but also to increase our forest cover.

People who live in or near forests know the value of forest resources first hand because their lives and livelihoods depend directly on these resources. However, the rest of us also derive great benefits from the forests which we are rarely aware of. The water we use depends on the existence of forests on the watersheds around river valleys. Our homes, furniture and paper are made from wood from the forest. We use many medicines that are based on forest produce. And we depend on the oxygen that plants give out and the removal of carbon dioxide we breathe out from the air.

Forests once extended over large tracts of our country. People have used forests in our country for thousands of years. As agriculture spread the forests were left in patches which were controlled mostly by tribal people. They hunted animals and gathered plants and lived entirely on forest resources. Deforestation became a major concern in British times when a large amount of timber was extracted for building their ships. This led the British to develop scientific forestry in India. They however alienated local people by creating Reserved and Protected Forests which curtailed access to the resources. This led to a loss of stake in the conservation of the forests which led to a gradual degradation and fragmentation of forests across the length and breadth of the country.

Another period of overutilisation and forest degradation occurred in the early period following independence as people felt that now that the British had gone they had a right to using our forests in any way we pleased. The following

FOREST FUNCTIONS

Watershed protection:

- Reduce the rate of surface run-off of water.
- Prevent flash floods and soil erosion.
- Produces prolonged gradual run-off and thus prevent effects of drought.

Atmospheric regulation:

- Absorption of solar heat during evapo-transpiration.
- Maintaining carbon dioxide levels for plant growth.
- Maintaining the local climatic conditions.

Erosion control:

- Holding soil (by preventing rain from directly washing soil away).

Land bank:

- Maintenance of soil nutrients and structure.

Local use - Consumption of forest produce by local people who collect it for subsistence – (Consumptive use)

- Food - gathering plants, fishing, hunting from the forest.
(In the past when wildlife was plentiful, people could hunt and kill animals for food. Now that populations of most wildlife species have diminished, continued hunting would lead to extinction.)
- Fodder - for cattle.
- Fuel wood and charcoal for cooking, heating.
- Poles - building homes especially in rural and wilderness areas.
- Timber – household articles and construction.
- Fiber - weaving of baskets, ropes, nets, string, etc.
- Sericulture – for silk.
- Apiculture - bees for honey, forest bees also pollinate crops.
- Medicinal plants - traditionally used medicines, investigating them as potential source for new modern drugs.

Market use - (Productive use)

- Most of the above products used for consumptive purposes are also sold as a source of income for supporting the livelihoods of forest dwelling people.
- Minor forest produce - (non-wood products): Fuelwood, fruit, gum, fiber, etc. which are collected and sold in local markets as a source of income for forest dwellers.
- Major timber extraction - construction, industrial uses, paper pulp, etc. Timber extraction is done in India by the Forest Department, but illegal logging continues in many of the forests of India and the world.

years saw India's residual forest wealth dwindle sharply. Timber extraction continued to remain the Forest Department's main concern up to the 1970s. The fact that forest degradation and deforestation was creating a serious loss of the important functions of the forest began to override its utilisation as a source of revenue from timber.

Deforestation: Where civilizations have looked after forests by using forest resources cautiously, they have prospered, where forests were destroyed, the people were gradually impoverished. Today logging and mining are serious causes of loss of forests in our country and all over the world. Dams built for hydroelectric power or irrigation have submerged forests and have displaced tribal people whose lives are closely knit to the forest. This has become a serious cause of concern in India.

One of India's serious environmental problems is forest degradation due to timber extraction and our dependence on fuelwood. A large number of poor rural people are still highly dependent on wood to cook their meals and heat their homes. We have not been able to plant enough trees to support the need for timber and fuelwood.

The National Forest Policy of 1988 now gives an added importance to JFM. Another resolution in 1990 provided a formal structure for community participation through the formation of Village Forest Committees. Based on these experiences, new JFM guidelines were issued in 2000. This stipulates that at least 25 per cent of the income from the area must go to the community. From the initiation of the program, until 2002, there were 63,618 JFM Committees managing over 140,953 sq. km of forest under JFM in 27 States in India.

The States have tried a variety of approaches to JFM. The share for village forest committees

Natural Resources

CASE STUDY

Joint Forest Management

The need to include local communities in Forest Management has become a growing concern. Local people will only support greening an area if they can see some economic benefit from conservation. An informal arrangement between local communities and the Forest Department began in 1972, in Midnapore District of West Bengal. JFM has now evolved into a formal agreement which identifies and respects the local community's rights and benefits that they need from forest resources. Under JFM schemes, Forest Protection Committees from local community members are formed. They participate in restoring green cover and protect the area from being over exploited.

ranges from 25 per cent in Kerala to 100 per cent in Andhra Pradesh, 50 per cent in Gujarat, Maharashtra, Orissa and Tripura. In many States 25 per cent of the revenue is used for village development. In many States non-timber forest products (NTFPs) are available for people free of cost.

Some States have stopped grazing completely; some have rotational grazing schemes which have helped in forest regeneration.

Timber extraction, mining and dams are invariably parts of the needs of a developing country. If timber is overharvested the ecological functions of the forest are lost. Unfortunately forests are located in areas where there are rich mineral resources. Forests also cover the steep embankments of river valleys, which are ideally suited to develop hydel and irrigation projects. Thus there is a constant conflict of interests be-

tween the conservation interests of environmental scientists and the Mining and Irrigation Departments. What needs to be understood is that long-term ecological gains cannot be sacrificed for short-term economic gains that unfortunately lead to deforestation. These forests where development projects are planned, can displace thousands of tribal people who lose their homes when these plans are executed. This leads to high levels of suffering for which there is rarely a satisfactory answer.

b) Water resources

The water cycle, through evaporation and precipitation, maintains hydrological systems which form rivers and lakes and support in a variety of aquatic ecosystems. Wetlands are intermediate forms between terrestrial and aquatic ecosystems and contain species of plants and animals that are highly moisture dependent. All aquatic ecosystems are used by a large number of people for their daily needs such as drinking water, washing, cooking, watering animals, and irrigating fields. The world depends on a limited quantity of fresh water. Water covers 70% of the earth's surface but only 3% of this is fresh water. Of this, 2% is in polar ice caps and only 1% is usable water in rivers, lakes and subsoil aquifers. Only a fraction of this can be actually used. At a global level 70% of water is used for agriculture about 25% for industry and only 5% for domestic use. However this varies in different countries and industrialized countries use a greater percentage for industry. India uses 90% for agriculture, 7% for industry and 3% for domestic use.

One of the greatest challenges facing the world in this century is the need to rethink the overall management of water resources. The world population has passed the 6 billion mark. Based on the proportion of young people in developing countries, this will continue to increase significantly during the next few decades. This

places enormous demands on the world's limited freshwater supply. The total annual freshwater withdrawals today are estimated at 3800 cubic kilometers, twice as much as just 50 years ago (World Commission on Dams, 2000). Studies indicate that a person needs a minimum of 20 to 40 liters of water per day for drinking and sanitation. More than one billion people worldwide have no access to clean water, and to many more, supplies are unreliable.

Local conflicts are already spreading to states. Eg. Karnataka and Tamil Nadu over the waters of the Krishna.

India is expected to face critical levels of water stress by 2025. At the global level 31 countries are already short of water and by 2025 there will be 48 countries facing serious water shortages. The UN has estimated that by the year 2050, 4 billion people will be seriously affected by water shortages. This will lead to multiple conflicts between countries over the sharing of water. Around 20 major cities in India face chronic or interrupted water shortages. There are 100 countries that share the waters of 13 large rivers and lakes. The upstream countries could starve the downstream nations leading to political unstable areas across the world. Examples are Ethiopia, which is upstream on the Nile and Egypt, which is downstream and highly dependent on the Nile. International accords that will look at a fair distribution of water in such areas will become critical to world peace. India and Bangladesh already have a negotiated agreement on the water use of the Ganges.

Overutilization and pollution of surface and groundwater: With the growth of human population there is an increasing need for larger amounts of water to fulfill a variety of basic needs. Today in many areas this requirement cannot be met. Overutilization of water occurs at various levels. Most people use more water than they really need. Most of us waste water

during a bath by using a shower or during washing of clothes. Many agriculturists use more water than necessary to grow crops. There are many ways in which farmers can use less water without reducing yields such as the use of drip irrigation systems.

Agriculture also pollutes surface water and underground water stores by the excessive use of chemical fertilizers and pesticides. Methods such as the use of biomass as fertilizer and non toxic pesticides such as neem products and using integrated pest management systems reduces the agricultural pollution of surface and ground water.

Industry tends to maximise short-term economic gains by not bothering about its liquid waste and releasing it into streams, rivers and the sea. In the longer term, as people become more conscious of using 'green products' made by ecosensitive industries, the polluter's products may not be used. The polluting industry that does not care for the environment and pays off bribes to get away from the cost needed to use effluent treatment plants may eventually be caught, punished and even closed down. Public awareness may increasingly put pressures on industry to produce only eco-friendly products which are already gaining in popularity.

As people begin to learn about the serious health hazards caused by pesticides in their food, public awareness can begin putting pressures on farmers to reduce the use of chemicals that are injurious to health.

CASE STUDY

Water pollution - Nepal

The Narayani River of Nepal has been polluted by factories located on its bank. This has endangered fish, dolphins, crocodiles and other flora and fauna of the region.

Natural Resources

Global climate change: Changes in climate at a global level caused by increasing air pollution have now begun to affect our climate. In some regions global warming and the El Nino winds have created unprecedented storms. In other areas, they lead to long droughts. Everywhere the 'greenhouse effect' due to atmospheric pollution is leading to increasingly erratic and unpredictable climatic effects. This has seriously affected regional hydrological conditions.

Floods: Floods have been a serious environmental hazard for centuries. However, the havoc raised by rivers overflowing their banks has become progressively more damaging, as people have deforested catchments and intensified use of river flood plains that once acted as safety valves. Wetlands in flood plains are nature's flood control systems into which overfilled rivers could spill and act like a temporary sponge holding the water, and preventing fast flowing water from damaging surrounding land.

Deforestation in the Himalayas causes floods that year after year kill people, damage crops and destroy homes in the Ganges and its tributaries and the Bramhaputra. Rivers change their course during floods and tons of valuable soil is lost to the sea. As the forests are degraded, rain-water no longer percolates slowly into the sub-soil but runs off down the mountainside bearing large amounts of topsoil. This blocks rivers temporarily but gives way as the pressure mounts allowing enormous quantities of water to wash suddenly down into the plains below. There, rivers swell, burst their banks and flood waters spread to engulf peoples' farms and homes.

Drought: In most arid regions of the world the rains are unpredictable. This leads to periods when there is a serious scarcity of water to drink, use in farms, or provide for urban and industrial use. Drought prone areas are thus faced with

irregular periods of famine. Agriculturists have no income in these bad years, and as they have no steady income, they have a constant fear of droughts. India has 'Drought Prone Areas Development Programs', which are used in such areas to buffer the effects of droughts. Under these schemes, people are given wages in bad years to build roads, minor irrigation works and plantation programs.

Drought has been a major problem in our country especially in arid regions. It is an unpredictable climatic condition and occurs due to the failure of one or more monsoons. It varies in frequency in different parts of our country.

While it is not feasible to prevent the failure of the monsoon, good environmental management can reduce its ill effects. The scarcity of water during drought years affects homes, agriculture and industry. It also leads to food shortages and malnutrition which especially affects children.

Several measures can be taken to minimise the serious impacts of a drought. However this must be done as a preventive measure so that if the monsoons fail its impact on local people's lives is minimised.

In years when the monsoon is adequate, we use up the good supply of water without trying to conserve it and use the water judiciously. Thus during a year when the rains are poor, there is no water even for drinking in the drought area.

One of the factors that worsens the effect of drought is deforestation. Once hill slopes are denuded of forest cover the rainwater rushes down the rivers and is lost. Forest cover permits water to be held in the area permitting it to seep into the ground. This charges the underground stores of water in natural aquifers. This can be used in drought years if the stores have been filled during a good monsoon. If water from the underground stores is overused, the

water table drops and vegetation suffers. This soil and water management and afforestation are long-term measures that reduce the impact of droughts.

Water for Agriculture and Power Generation: India's increasing demand for water for intensive irrigated agriculture, for generating electricity, and for consumption in urban and industrial centers, has been met by creating large dams. Irrigated areas increased from 40 million ha. in 1900 to 100 million ha. in 1950 and to 271 million ha. by 1998. Dams support 30 to 40% of this area.

Although dams ensure a year round supply of water for domestic use, provide extra water for agriculture, industry, hydropower generation, they have several serious environmental problems. They alter river flows, change nature's flood control mechanisms such as wetlands and flood plains, and destroy the lives of local people and the habitats of wild plant and animal species.

Irrigation to support cash crops like sugarcane produces an unequal distribution of water. Large landholders on the canals get the lion's share of water, while poor, small farmers get less and are seriously affected.

Sustainable water management: 'Save water' campaigns are essential to make people everywhere aware of the dangers of water scarcity. A number of measures need to be taken for the better management of the world's water resources. These include measures such as:

- Building several small reservoirs instead of few mega projects.
- Develop small catchment dams and protect wetlands.

- Soil management, micro catchment development and afforestation permits recharging of underground aquifers thus reducing the need for large dams.
- Treating and recycling municipal waste water for agricultural use.
- Preventing leakages from dams and canals.
- Preventing loss in Municipal pipes.
- Effective rain water harvesting in urban environments.
- Water conservation measures in agriculture such as using drip irrigation.
- Pricing water at its real value makes people use it more responsibly and efficiently and reduces water wasting.
- In deforested areas where land has been degraded, soil management by bunding along the hill slopes and making 'nala' plugs, can help retain moisture and make it possible to re-vegetate degraded areas.

Managing a river system is best done by leaving its course as undisturbed as possible. Dams and canals lead to major floods in the monsoon and the drainage of wetlands seriously affects areas that get flooded when there is high rainfall.

Dams: Today there are more than 45,000 large dams around the world, which play an important role in communities and economies that harness these water resources for their economic development. Current estimates suggest some 30-40% of irrigated land worldwide relies on dams. Hydropower, another contender for the use of stored water, currently supplies 19% of the world's total electric power supply and is used in over 150 countries. The world's two most populous countries – China and India –

have built around 57% of the world's large dams.

Dams problems

- Fragmentation and physical transformation of rivers.
- Serious impacts on riverine ecosystems.
- Social consequences of large dams due to displacement of people.
- Water logging and salinisation of surrounding lands.
- Dislodging animal populations, damaging their habitat and cutting off their migration routes.
- Fishing and travel by boat disrupted.
- The emission of green house gases from reservoirs due to rotting vegetation and carbon inflows from the catchment is a recently identified impact.

Large dams have had serious impacts on the lives, livelihoods, cultures and spiritual existence of indigenous and tribal peoples. They have suffered disproportionately from the negative impacts of dams and often been excluded from sharing the benefits. In India, of the 16 to 18 million people displaced by dams, 40 to 50% were tribal people, who account for only 8% of our nation's one billion people.

Conflicts over dams have heightened in the last two decades because of their social and environmental impacts and failure to achieve targets for sticking to their costs as well as achieving promised benefits. Recent examples show how failure to provide a transparent process that includes effective participation of local people has prevented affected people from playing an

active role in debating the pros and cons of the project and its alternatives. The loss of traditional, local controls over equitable distribution remains a major source of conflict.

In India, a national assessment of dam projects cleared in the 1980s and 90s shows that in 90% of cases the project authorities have not fulfilled the environmental conditions under which environmental clearance was given by the GOI under the EPA of 1986.

CASE STUDY

Sardar Sarovar Project

The World Bank's withdrawal from the Sardar Sarovar Project in India in 1993 was a result of the demands of local people threatened with the loss of their livelihoods and homes in the submergence area.

This dam in Gujarat on the Narmada has displaced thousands of tribal folk, whose lives and livelihoods were linked to the river, the forests and their agricultural lands. While they and the fishermen at the estuary, have lost their homeland, rich farmers downstream will get water for agriculture. The question is why should the local tribals be made homeless, displaced and relocated to benefit other people? Why should the less fortunate be made to bear the costs of development for better off farmers? It is a question of social and economic equity as well as the enormous environmental losses, including loss of the biological diversity of the inundated forests in the Narmada valley.

Activity 4:

How much water is needed by one person? Several international agencies and experts have proposed that 50 liters per person per day covers basic human water requirements for drinking, sanitation, bathing and food preparation. Estimate your average daily consumption.

c) Mineral Resources

A mineral is a naturally occurring substance of definite chemical composition and identifiable physical properties. An ore is a mineral or combination of minerals from which a useful substance, such as a metal, can be extracted and used to manufacture a useful product.

Minerals are formed over a period of millions of years in the earth's crust. Iron, aluminum, zinc, manganese and copper are important raw materials for industrial use. Important non-metal resources include coal, salt, clay, cement and silica. Stone used for building material, such as granite, marble, limestone, constitute another category of minerals. Minerals with special properties that humans value for their aesthetic and ornamental value are gems such as diamonds, emeralds, rubies. The luster of gold, silver and platinum is used for ornaments. Minerals in the form of oil, gas and coal were formed when ancient plants and animals were converted into underground fossil fuels.

Minerals and their ores need to be extracted from the earth's interior so that they can be used. This process is known as mining. Mining operations generally progress through four stages:

- (1) Prospecting: Searching for minerals.
- (2) Exploration: Assessing the size, shape, location, and economic value of the deposit.

- (3) Development: Work of preparing access to the deposit so that the minerals can be extracted from it.
- (4) Exploitation: Extracting the minerals from the mines.

In the past, mineral deposits were discovered by prospectors in areas where mineral deposits in the form of veins were exposed on the surface. Today, however, prospecting and exploration is done by teams of geologists, mining engineers, geophysicists, and geochemists who work together to discover new deposits. Modern prospecting methods include the use of sophisticated instruments like GIS to survey and study the geology of the area.

The method of mining has to be determined depending on whether the ore or mineral deposit is nearer the surface or deep within the earth. The topography of the region and the physical nature of the ore deposit is studied.

Mines are of two types – surface (open cut or strip mines) or deep or shaft mines. Coal, metals and non-metalliferous minerals are all mined differently depending on the above criteria. The method chosen for mining will ultimately depend on how maximum yield may be obtained under existing conditions at a minimum cost, with the least danger to the mining personnel.

Most minerals need to be processed before they become usable. Thus 'technology' is dependent on both the presence of resources and the energy necessary to make them 'usable'.

Mine safety: Mining is a hazardous occupation, and the safety of mine workers is an important environmental consideration of the industry. Surface mining is less hazardous than underground mining. Metal mining is less hazardous than coal mining. In all underground mines, rock and roof falls, flooding, and inad-

CASE STUDY

Sariska Tiger Reserve, Rajasthan

The Forest Department has leased land for mining in the Sariska Tiger Reserve area by denotifying forest areas. The local people have fought against the mining lobby, and have filed a Public Interest Litigation in the Supreme Court in 1991. Rajendra Singh, secretary of TBS, points out that as many as 70 mines operate in close proximity to the forest.

equate ventilation are the greatest hazards. Large explosions have occurred in coal mines, killing many miners. More miners have suffered from disasters due to the use of explosives in metal mines.

Mining poses several long-term occupational hazards to the miners. Dust produced during mining operations is injurious to health and causes a lung disease known as black lung, or pneumoconiosis. Fumes generated by incomplete dynamite explosions are extremely poisonous. Methane gas, emanating from coal strata, is hazardous to health although not poisonous in the concentrations usually encountered in mine air. Radiation is a hazard in uranium mines.

Environmental problems: Mining operations are considered one of the main sources of environmental degradation. The extraction of all these products from the lithosphere has a variety of side effects. Depletion of available land due to mining, waste from industries, conversion of land to industry and pollution of land, water and air by industrial wastes, are environmental side effects of the use of these non-renewable resources. Public awareness of this

problem is of a global nature and government actions to stem the damage to the natural environment have led to numerous international agreements and laws directed toward the prevention of activities and events that may adversely affect the environment.

d) Food resources

Today our food comes almost entirely from agriculture, animal husbandry and fishing. Although India is self-sufficient in food production, it is only because of modern patterns of agriculture that are unsustainable and which pollute our environment with excessive use of fertilizers and pesticides.

The FAO defines sustainable agriculture as that which conserves land, water and plant and animal genetic resources, does not degrade the environment and is economically viable and socially acceptable. Most of our large farms grow single crops (monoculture). If this crop is hit by a pest, the entire crop can be devastated, leaving the farmer with no income during the year. On the other hand, if the farmer uses traditional varieties and grows several different crops, the chance of complete failure is lowered considerably. Many studies have shown that one can use alternatives to inorganic fertilizers and pesticides. This is known as **Integrated Crop Management**.

World food problems: In many developing countries where populations are expanding rapidly, the production of food is unable to keep pace with the growing demand. Food production in 64 of the 105 developing countries is lagging behind their population growth levels. These countries are unable to produce more food, or do not have the financial means to import it. India is one of the countries that have been able to produce enough food by cultivating a large proportion of its arable land through

irrigation. The Green Revolution of the 60's reduced starvation in the country. However many of the technologies we have used to achieve this are now being questioned.

- Our fertile soils are being exploited faster than they can recuperate.
- Forests, grasslands and wetlands have been converted to agricultural use, which has led to serious ecological questions.
- Our fish resources, both marine and inland, show evidence of exhaustion.
- There are great disparities in the availability of nutritious food. Some communities such as tribal people still face serious food problems leading to malnutrition especially among women and children.

These issues bring in new questions as to how demands will be met in future even with a slowing of population growth. Today the world is seeing a changing trend in dietary habits. As living standards are improving, people are eating more non-vegetarian food. As people change from eating grain to meat, the world's demand for feed for livestock based on agriculture increases as well. This uses more land per unit of food produced and the result is that the world's poor do not get enough to eat.

Women play an extremely vital role in food production as well as cooking the meal and feeding children. In most rural communities they have the least exposure to technical training and to health workers trained in teaching/learning on issues related to nutritional aspects. Women and girls frequently receive less food than the men. These disparities need to be corrected.

In India there is a shortage of cultivable productive land. Thus farm sizes are too small to support a family on farm produce alone. With each generation, farms are being subdivided further.

Poor environmental agricultural practices such as slash and burn, shifting cultivation, or 'rab' (woodash) cultivation degrade forests.

Globally 5 to 7 million hectares of farmland is degraded each year. Loss of nutrients and overuse of agricultural chemicals are major factors in land degradation. Water scarcity is an important aspect of poor agricultural outputs. Salinization and water logging has affected a large amount of agricultural land worldwide.

Loss of genetic diversity in crop plants is another issue that is leading to a fall in agricultural produce. Rice, wheat and corn are the staple foods of two thirds of the world's people. As wild relatives of crop plants in the world's grasslands, wetlands and other natural habitats are being lost, the ability to enhance traits that are resistant to diseases, salinity, etc. is lost. Genetic engineering is an untried and risky alternative to traditional cross breeding.

Food Security: It is estimated that 18 million people worldwide, most of whom are children, die each year due to starvation or malnutrition, and many others suffer a variety of dietary deficiencies.

The earth can only supply a limited amount of food. If the world's carrying capacity to produce food cannot meet the needs of a growing population, anarchy and conflict will follow. Thus food security is closely linked with population control through the family welfare program. It is also linked to the availability of water for farming. Food security is only possible if food is equitably distributed to all. Many of us waste a large amount of food carelessly. This eventually places great stress on our environmental resources.

A major concern is the support needed for small farmers so that they remain farmers rather than shifting to urban centers as unskilled industrial workers. International trade policies in regard

to an improved flow of food across national borders from those who have surplus to those who have a deficit in the developing world is another issue that is a concern for planners who deal with International trade concerns. 'Dumping' of underpriced foodstuffs produced in the developed world, onto markets in undeveloped countries undermines prices and forces farmers there to adopt unsustainable practices to compete.

Fisheries: Fish is an important protein food in many parts of the world. This includes marine and fresh water fish. While the supply of food from fisheries increased phenomenally between 1950 and 1990, in several parts of the world fish catch has since dropped due to overfishing. In 1995 FAO reported that 44% of the world's fisheries are fully or heavily exploited, 16% are already overexploited, 6% are depleted, and only 3% are gradually recovering. Canada had to virtually close down cod fishing in the 1990s due to depletion of fish reserves.

Modern fishing technologies using mechanized trawlers and small meshed nets lead directly to overexploitation, which is not sustainable. It is evident that fish have to breed successfully and need to have time to grow if the yield has to be used sustainably. The worst hit are the small traditional fishermen who are no match for organized trawlers.

Loss of Genetic diversity: There are 50,000 known edible plants documented worldwide. Of these only 15 varieties produce 90% of the world's food. Modern agricultural practices have resulted in a serious loss of genetic variability of crops. India's distinctive traditional varieties of rice alone are said to have numbered between 30 and 50 thousand. Most of these have been lost to the farmer during the last few decades as multinational seed companies push a few commercial types.

This creates a risk to our food security, as farmers can lose all their produce due to a rapidly spreading disease. A cereal that has multiple varieties growing in different locations does not permit the rapid spread of a disease.

The most effective method to introduce desirable traits into crops is by using characteristics found in the wild relatives of crop plants. As the wilderness shrinks, these varieties are rapidly disappearing. Once they are lost, their desirable characteristics cannot be introduced when found necessary in future. Ensuring long-term food security may depend on conserving wild relatives of crop plants in National Parks and Wildlife Sanctuaries.

If plant genetic losses worldwide are not slowed down, some estimates show that as many as 60,000 plant species, which accounts for 25% of the world's total, will be lost by the year 2025. The most economical way to prevent this is by expanding the network and coverage of our Protected Areas. Collections in germplasm, seed banks and tissue culture facilities, are other possible ways to prevent extinction but are extremely expensive.

Scientists now believe that the world will soon need a second green revolution to meet our future demands of food based on a new ethic of land and water management that must be based on values which include environmental sensitivity, equity, biodiversity conservation of cultivars and insitu preservation of wild relatives of crop plants. This must not only provide food for all, but also work out more equitable distribution of both food and water, reduce agricultural dependence on the use of fertilizers and pesticides (which have long term ill effects on human wellbeing) and provide an increasing support for preserving wild relatives of crop plants in Protected Areas. Pollution of water sources, land degradation and desertification must be rapidly reversed. Adopting soil conservation measures, using appropriate farming

techniques, especially on hill slopes, enhancing the soil with organic matter, rotating crops and managing watersheds at the micro level are a key to agricultural production to meet future needs. Most importantly food supply is closely linked to the effectiveness of population control programs worldwide. The world needs better and sustainable methods of food production which is an important aspect of landuse management.

Alternate food sources: Food can be innovatively produced if we break out of the current agricultural patterns. This includes working on new avenues to produce food, such as using forests for their multiple non-wood forest products, which can be used for food if harvested sustainably. This includes fruit, mushrooms, sap, gum, etc. This takes time, as people must develop a taste for these new foods.

CASE STUDY

Israel began using drip irrigation systems as it is short of water. With this technique, farmers have been able to improve the efficiency of irrigation by 95%. Over a 20-year period, Israel's food production doubled without an increase in the use of water for agriculture.

In India, some traditional communities in urban and semi urban towns used to grow their own vegetables in backyards on wastewater from their own homes. Calcutta releases its waste water into surrounding lagoons in which fish are reared and the water is used for growing vegetables.

Medicines, both traditional and modern, can be harvested sustainably from forests. Madagascar's Rosy Periwinkle used for childhood leukemia's and Taxol from Western Yew

from the American Northwest as an anticancer drug are examples of forest products used extensively in modern medicine. Without care, commercial exploitation can lead to early extinction of such plants.

Using unfamiliar crops such as Nagli, which are grown on poor soil on hill slopes is another option. This crop grown in the Western Ghats now has no market and is thus rarely grown. Only local people use this nutritious crop themselves. It is thus not as extensively cultivated as in the past. Popularising this crop could add to food availability from marginal lands. Several crops can be grown in urban settings, including vegetables and fruit which can be grown on waste household water and fertilizers from vermicomposting pits.

Several foods can be popularized from yet unused seafood products such as seaweed as long as this is done at sustainable levels. Educating women about nutrition, who are more closely involved with feeding the family, is an important aspect of supporting the food needs of many developing countries.

Integrated Pest Management includes preserving pest predators, using pest resistant seed varieties and reducing the use of chemical fertilizers.

e) Energy resources

Energy is defined by physicists as the capacity to do work. Energy is found on our planet in a variety of forms, some of which are immediately useful to do work, while others require a process of transformation.

The sun is the primary energy source in our lives. We use it directly for its warmth and through various natural processes that provide us with

Natural Resources

food, water, fuel and shelter. The sun's rays power the growth of plants, which form our food material, give off oxygen

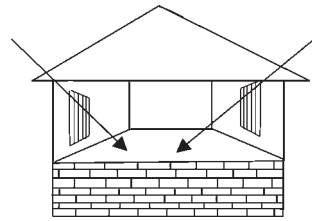

which we breathe in and take up carbon dioxide that we breathe out. Energy from the sun evaporates water from oceans, rivers and lakes, to form clouds that turn into rain. Today's fossil fuels were once the forests that grew in prehistoric times due to the energy of the sun.

Chemical energy, contained in chemical compounds is released when they are broken down by animals in the presence of oxygen. In India, manual labour is still extensively used to get work done in agricultural systems, and domestic animals used to pull carts and ploughs. Electrical energy produced in several ways, powers transport, artificial lighting, agriculture and industry. This comes from hydel power based on the water cycle that is powered by the sun's energy that supports evaporation, or from thermal power stations powered by fossil fuels. Nuclear energy is held in the nucleus of an atom and is now harnessed to develop electrical energy.

We use energy for household use, agriculture, production of industrial goods and for running transport. Modern agriculture uses chemical fertilizers, which require large amounts of energy during their manufacture.

Industry uses energy to power

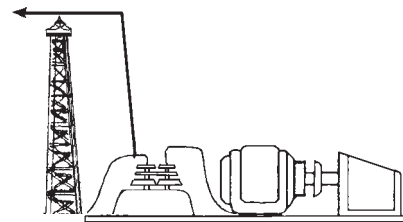

manufacturing units and the urban complexes that support it. Energy-demanding roads and railway lines are built to transport products from place to place and to reach raw materials in mines and forests.

No energy related technology is completely 'risk free' and unlimited demands on energy increase this risk factor many fold. All energy use creates heat and contributes to atmospheric temperature. Many forms of energy release carbon dioxide and lead to global warming. Nuclear energy plants have caused enormous losses to the environment due to the leakage of nuclear material. The inability to effectively manage and safely dispose of nuclear waste is a serious global concern.

At present almost 2 billion people worldwide have no access to electricity at all. While more people will require electrical energy, those who do have access to it continue to increase their individual requirements. In addition, a large proportion of energy from electricity is wasted during transmission as well as at the user level. It is broadly accepted that long-term trends in energy use should be towards a cleaner global energy system that is less carbon intensive and less reliant on finite non-renewable energy sources. It is estimated that the currently used methods of using renewable energy and non renewable fossil fuel sources together will be insufficient to meet foreseeable global demands for power generation beyond the next 50 to 100 years.

Thus when we use energy wastefully, we are contributing to a major environmental disaster for our earth. We all need to become responsible energy users. An electrical light that is burning unnecessarily is a contributor to environmental degradation.

Growing energy needs: Energy has always been closely linked to man's economic growth and development. Present strategies for development that have focused on rapid economic growth have used energy utilization as an index of economic development. This index however, does not take into account the long-term ill effects on society of excessive energy utilisation.

In 1998, the World Resources Institute found that the average American uses 24 times the energy used by an Indian.

Between 1950 and 1990, the world's energy needs increased four fold. The world's demand for electricity has doubled over the last 22 years! The world's total primary energy consumption in 2000 was 9096 million tons of oil. A global average per capita that works out to be 1.5 tons of oil. Electricity is at present the fastest growing form of end-use energy worldwide. By 2005 the Asia-Pacific region is expected to surpass North America in energy consumption and by 2020 is expected to consume some 40% more energy than North America.

For almost 200 years, coal was the primary energy source fuelling the industrial revolution in the 19th century. At the close of the 20th century, oil accounted for 39% of the world's commercial energy consumption, followed by coal (24%) and natural gas (24%), while nuclear (7%) and hydro/renewables (6%) accounted for the rest.

Among the commercial energy sources used in India, coal is a predominant source accounting for 55% of energy consumption estimated in 2001, followed by oil (31%), natural gas (8%), hydro (5%) and nuclear (1%).

In India, biomass (mainly wood and dung) accounts for almost 40% of primary energy supply. While coal continues to remain the dominant fuel for electricity generation, nuclear power has been increasingly used since the 1970s and 1980s and the use of natural gas has increased rapidly in the 80s and 90s.

Types of energy: There are three main types of energy; those classified as **non-renewable**; those that are said to be **renewable**; and **nuclear energy**, which uses such small quantities of raw material (uranium) that supplies are to all effect, limitless. However, this classification is inaccurate because several of the renewable sources, if not used 'sustainably', can be depleted more quickly than they can be renewed.

Non renewable energy

To produce electricity from non-renewable resources the material must be ignited. The fuel is placed in a well contained area and set on fire. The heat generated turns water to steam, which moves through pipes, to turn the blades of a turbine. This converts magnetism into electricity, which we use in various appliances.

Non-Renewable Energy Sources: These consist of the mineral based hydrocarbon fuels coal, oil and natural gas, that were formed from ancient prehistoric forests. These are called 'fossil fuels' because they are formed after plant life is fossilized. At the present rate of extraction there is enough coal for a long time to come. Oil and gas resources however are likely to be used up within the next 50 years. When these fuels are burnt, they produce waste products that are released into the atmosphere as gases such as carbon dioxide, oxides of sulphur, nitrogen, and carbon monoxide, all causes of air pollution. These have led to lung problems in an enormous number of people all over the world, and have also affected buildings like the Taj Mahal and killed many forests and lakes due to acid rain. Many of these gases also act like a green house letting sunlight in and trapping the heat inside. This is leading to global warming, a raise in global temperature, increased drought in some areas, floods in other regions, the melting of icecaps, and a rise in sea levels, which is slowly submerging coastal belts all over the world.

Natural Resources

Warming the seas also leads to the death of sensitive organisms such as coral.

Oil and its environmental impacts: India's oil reserves which are being used at present lie off the coast of Mumbai and in Assam. Most of our natural gas is linked to oil and, because there is no distribution system, it is just burnt off. This wastes nearly 40% of available gas. The processes of oil and natural gas drilling, processing, transport and utilisation have serious environmental consequences, such as leaks in which air and water are polluted and accidental fires that may go on burning for days or weeks before the fire can be controlled. During refining oil, solid waste such as salts and grease are produced which also damage the environment. Oil slicks are caused at sea from offshore oil wells, cleaning of oil tankers and due to shipwrecks. The most well-known disaster occurred when the Exxon

Valdez sank in 1989 and birds, sea otters, seals, fish and other marine life along the coast of Alaska was seriously affected.

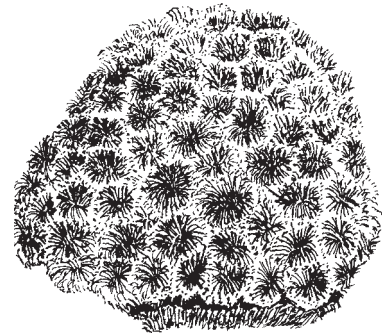

Oil powered vehicles emit carbon dioxide, sulphur dioxide, nitrous oxide, carbon monoxide and particulate matter which is a major cause of air pollution especially in cities with heavy traffic density. Leaded petrol, leads to neuro damage and reduces attention spans. Running petrol vehicles with unleaded fuel has been achieved by adding catalytic converters on all the new cars, but unleaded fuel contains benzene and butadene which are known to be carcinogenic compounds. Delhi, which used to have serious

smog problems due to traffic, has been able to reduce this health hazard by changing a large number of its vehicles to CNG, which contains methane.

Dependence on dwindling fossil fuel resources, especially oil, results in political tension, instability and war. At present 65 percent of the world's oil reserves are located in the Middle East.

Coal and its environmental impacts: Coal is the world's single largest contributor of green house gases and is one of the most important causes of global warming.

Many coal-based power generation plants are not fitted with devices such as electrostatic precipitators to reduce emissions of suspended particulate matter (SPM) which is a major contributor to air pollution. Burning coal also produces oxides of sulphur and nitrogen which, combined with water vapour, lead to 'acid rain'. This kills forest vegetation, and damages architectural heritage sites, pollutes water and affects human health.

Thermal power stations that use coal produce waste in the form of 'fly ash'. Large dumps are required to dispose off this waste material, while efforts have been made to use it for making bricks. The transport of large quantities of fly ash and its eventual dumping are costs that have to be included in calculating the cost-benefits of thermal power.

CASE STUDY

The Exxon Valdez was wrecked in Prince William Sound in Alaska in 1989 and polluted large parts of the surrounding seas.

CASE STUDY

Oil related disasters

During the Gulf War, oil installations burned for weeks polluting the air with poisonous gasses. The fires wasted 5 million barrels of oil and produced over a million tons of airborne pollutants, including sulphur dioxide, a major cause of acid rain. The gases moved to a height of 3km and spread as far as India. Oil also polluted coastlines, killing birds and fish.

Renewable energy

Renewable energy systems use resources that are constantly replaced and are usually less polluting. Examples include hydropower, solar, wind, and geothermal (energy from the heat inside the earth). We also get renewable energy from burning trees and even garbage as fuel and processing other plants into biofuels.

One day, all our homes may get their energy from the sun or the wind. Your car's gas tank will use biofuel. Your garbage might contribute to your city's energy supply. Renewable energy technologies will improve the efficiency and cost of energy systems. We may reach the point when we may no longer rely mostly on fossil fuel energy.

CASE STUDY

Nearly 50% of the world's population is dependent on fuel wood as a source of energy. This is obvious in our own country, which has lost a large proportion of its forest cover as our population expands and burns enormous amounts of wood. Rural women, and even women from the lower economic strata in towns, still have to spend a large part of their lives collecting fuel wood. To overcome this, various types of fuel-efficient stoves ('chulas') can burn wood extremely slowly and do not waste the heat, and also produce less smoke and ash than normal 'chulas'. There have also been several efforts to grow fuelwood by involving local people in these efforts. Examples include Social Forestry, Farm Forestry and Joint Forestry Management.

CASE STUDY

In 1882, the first Hydroelectric power dam was built in Appleton, Wisconsin. In India the first hydroelectric power dams were built in the late 1800s and early 1900s by the Tatas in the Western Ghats of Maharashtra. Jamshedjee Tata, a great visionary who developed industry in India in the 1800s, wished to have a clean source of energy to run cotton and textile mills in Bombay as he found people were getting respiratory infections due to coal driven mills. He thus asked the British Government to permit him to develop dams in the Western Ghats to generate electricity. The four dams are the Andhra, Shirovata, Valvan and Mulshi hydel dams. An important feature of the Tata power projects is that they use the high rainfall in the hills as storage areas. While the rivers flowing eastwards from the Western Ghats are dammed in the foothills near the Deccan plateau, the water is tunneled through the crest of the Ghats to drop several hundred meters to the coastal belt. Large turbines in the power plants generate electricity for Mumbai and its giant industrial belt.

Hydroelectric Power

This uses water flowing down a natural gradient to turn turbines to generate electricity known as 'hydroelectric power' by constructing dams across rivers. Between 1950 and 1970, Hydropower generation worldwide increased

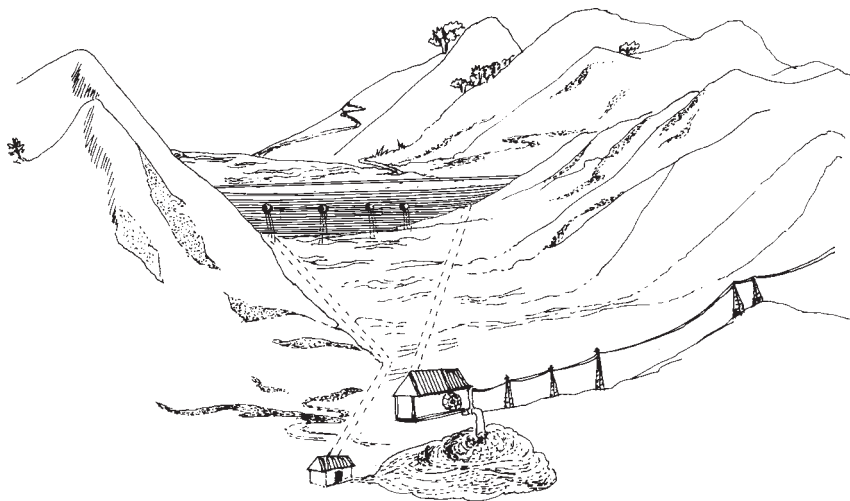

seven times. The long life of hydropower plants, the renewable nature of the energy source, very low operating and maintenance costs, and absence of inflationary pressures as in fossil fuels, are some of its advantages.

Drawbacks: Although hydroelectric power has led to economic progress around the world, it has created serious ecological problems.

- To produce hydroelectric power, large areas of forest and agricultural lands are submerged. These lands traditionally provided a livelihood for local tribal people and farmers. Conflicts over land use are inevitable.
- Silting of the reservoirs (especially as a result of deforestation) reduces the life of the hydroelectric power installations.
- Water is required for many other purposes besides power generation. These include domestic requirements, growing agricultural crops and for industry. This gives rise to conflicts.
- The use of rivers for navigation and fisheries becomes difficult once the water is dammed for generation of electricity.
- Resettlement of displaced persons is a problem for which there is no ready solution. The opposition to many large hydroelectric schemes is growing as most dam projects have been unable to resettle people that were affected and displaced.
- In certain regions large dams can induce seismic activity which will result in earthquakes. There is a great possibility of this occurring around the Tehri dam in the Himalayan foothills. Shri Sunderlal Bahuguna, the initiator of the Chipko Movement has fought against the Tehri Dam for several years.

CASE STUDY

Narmada Project

The Narmada Bachao Andolan in India is an example of a movement against large dams. The gigantic Narmada River Project has affected the livelihoods of hundreds of extremely poor forest dwellers. The rich landholders downstream from the Sardar Sarovar dam will derive the maximum economic benefit, whereas the poor tribal people have lost their homes and traditional way of life. The dam will also destroy the livelihood of fishermen at the estuary. The disastrous impact that this project has on the lives of the poor, and the way in which they are being exploited, need to be clearly understood.

With large dams causing social problems, there has been a trend to develop small hydroelectric generation units. Multiple small dams have less impact on the environment. China has the largest number of these - 60,000, generating 13,250 megawatts, i.e. 30% of China's electricity. Sweden, the US, Italy and France also have developed small dams for electrical power generation. The development of small hydroelectric power units could become a very important resource in India, which has steeply falling rivers and the economic capability and technical resources to exploit them.

Solar energy: In one hour, the sun pours as much energy onto the earth as we use in a whole year. If it were possible to harness this colossal quantum of energy, humanity would need no other source of energy. Today we have developed several methods of collecting this energy for heating water and generating electricity.

Solar heating for homes: Modern housing that uses air conditioning and/ or heating are extremely energy dependant. A passive solar home or building is designed to collect the sun's heat through large, south-facing glass windows. In solar heated buildings, *sunspaces* are built on the south side of the structure which act as large heat absorbers. The floors of sunspaces are usually made of tiles or bricks that absorb heat throughout the day, then release heat at night when its cold.

In energy efficient architecture the sun, water and wind are used to heat a building when the weather is cold and to cool it in summer. This is based on design and building material. Thick walls of stone or mud were used in traditional architecture as an insulator. Small doors and windows kept direct sunlight and heat out. Deeply set glass windows in colonial homes, on which direct sunlight could not reach, permitted the glass from creating a green house effect. Verandahs also served a similar purpose.

Traditional bungalows had high roofs and ventilators that permitted hot air to rise and leave the room. Cross ventilation where wind can drive the air in and out of a room keeps it cool. Large overhangs over windows prevent the glass from heating the room inside. Double walls are used to prevent heating. Shady trees around the house help reduce temperature.

Solar water heating: Most solar water-heating systems have two main parts: the solar *collector* and the *storage tank*. The solar energy collector heats the water, which then flows to a well insulated storage tank.

A common type of collector is the *flat-plate collector*, a rectangular box with a transparent cover that faces the sun, usually mounted on the roof. Small tubes run through the box, carrying the water or other fluid, such as antifreeze, to be heated. The tubes are mounted on a metal *absorber plate*, which is painted black to ab-

sorb the sun's heat. The back and sides of the box are insulated to hold in the heat. Heat builds up in the collector, and as the fluid passes through the tubes, it too heats up.

Solar water-heating systems cannot heat water when the sun is not shining. Thus homes must also have a conventional backup system. About 80% of homes in Israel have solar hot water heaters.

Solar cookers: The heat produced by the sun can be directly used for cooking using solar cookers. A solar cooker is a metal box which is black on the inside to absorb and retain heat. The lid has a reflective surface to reflect the heat from the sun into the box. The box contains black vessels in which the food to be cooked is placed.

India has the world's largest solar cooker program and an estimated 2 lakh families that use solar cookers. Although solar cookers reduce the need for fuel wood and pollution from smoky wood fires, they have not caught on well in rural areas as they are not suitable to traditional cooking practices. However, they have great potential if marketed well.

Other Solar-Powered Devices: Solar desalination systems (for converting saline or brackish water into pure distilled water) have been developed. In future, they should become important alternatives for man's future economic growth in areas where fresh water is not available.

Photovoltaic energy: The solar technology which has the greatest potential for use throughout the world is that of solar photo voltaic cells which directly produce electricity from sunlight using *photovoltaic (PV)* (also called *solar*) cells.

Solar cells use the sun's light, not its heat, to make electricity. PV cells require little maintenance, have no moving parts, and essentially no environmental impact. They work cleanly,

Photovoltaic Cells

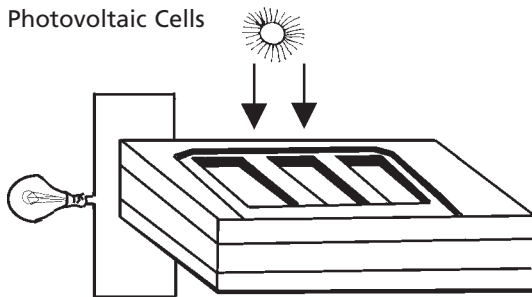

safely and silently. They can be installed quickly in small modules, anywhere there is sunlight. Solar cells are made up of two separate layers of silicon, each of which contains an electric charge. When light hits the cells, the charges begin to move between the two layers and electricity is produced. PV cells are wired together to form a module. A module of about 40 cells is enough to power a light bulb. For more power, PV modules are wired together into an array. PV arrays can produce enough power to meet the electrical needs of a home. Over the past few years, extensive work has been done in decreasing PV technology costs, increasing efficiency, and extending cell lifetimes. Many new materials, such as amorphous silicon, are being tested to reduce costs and automate manufacturing.

PV cells are commonly used today in calculators and watches. They also provide power to satellites, electric lights, and small electrical appliances such as radios and for water pumping, highway lighting, weather stations, and other electrical systems located away from power lines. Some electric utility companies are building PV systems into their power supply networks.

PV cells are environmentally benign, i.e. they do not release pollutants or toxic material to the air or water, there is no radioactive substance, and no catastrophic accidents. Some PV cells, however, do contain small quantities of toxic substances such as cadmium and these can be released to the environment in the event of a fire. Solar cells are made of silicon which, al-

CASE STUDIES

- In 1981, a plane called 'The Solar Challenger' flew from Paris to England in 5 hours, 20 minutes. It had 16,000 solar cells glued to the wings and tail of the plane and they produced enough power to drive a small electric motor and propeller. Since 1987, every three years there is a World Solar challenge for solar operated vehicles in Australia where the vehicles cover 3000 kms.
- The world's first solar-powered hospital is in Mali in Africa. Being situated at the edge of the Sahara desert, Mali receives a large amount of sunlight. Panels of solar cells supply the power needed to run vital equipment and keep medical supplies cool in refrigerators.
- Space technology required solar energy and the space race spurred the development of solar cells. Only sunlight can provide power for long periods of time for a space station or long distance spaceship.
- Japanese farmers are substituting PV operated insect killers for toxic pesticides.
- In recent years, the popularity of building integrated photovoltaics (BIPV's) has grown considerably. In this application, PV devices are designed as part of building materials (i.e. roofs and siding) both to produce electricity and reduce costs by replacing the costs of normal construction materials. There are more than 3,000 BIPV systems in Germany and Japan has a program that will build 70,000 BIPV buildings.

though the second most abundant element in the earth's crust, has to be mined. Mining creates environmental problems. PV systems also of course only work when the sun is shining, and thus need batteries to store the electricity.

Solar thermal electric power: Solar radiation can produce high temperatures, which can generate electricity. Areas with low cloud levels of cover with little scattered radiation as in the desert are considered most suitable sites. According to a UNDP assessment, STE is about 20 years behind the wind energy market exploitation, but is expected to grow rapidly in the near future.

Mirror energy: During the 1980s, a major solar thermal electrical generation unit was built in California, containing 700 parabolic mirrors, each with 24 reflectors, 1.5 meters in diameter, which focused the sun's energy to produce steam to generate electricity.

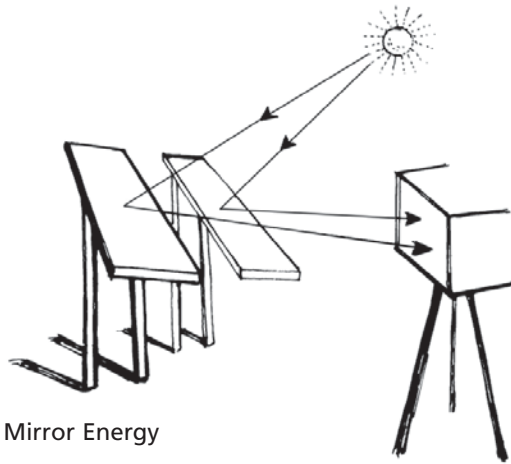

Solar thermal systems change sunlight into electricity, by focusing sunlight to boil water to make steam.

Natural Resources

Biomass energy: When a log is burned we are using *biomass energy*. Because plants and trees depend on sunlight to grow, biomass energy is a form of stored solar energy. Although wood is the largest source of biomass energy, we also use agricultural waste, sugarcane wastes, and other farm byproducts to make energy.

There are three ways to use biomass. It can be burned to produce heat and electricity, changed to a gas-like fuel such as methane, or changed to a liquid fuel. Liquid fuels, also called *biofuels*, include two forms of alcohol: *ethanol* and *methanol*. Because biomass can be changed directly into liquid fuel, it could someday supply much of our transportation fuel needs for cars, trucks, buses, airplanes and trains with diesel fuel replaced by '*biodiesel*' made from vegetable oils. In the United States, this fuel is now being produced from soybean oil. Researchers are also developing algae that produce oils, which can be converted to biodiesel and new ways have been found to produce ethanol from grasses, trees, bark, sawdust, paper, and farming wastes.

Organic municipal solid waste includes paper, food wastes, and other organic non-fossil-fuel derived materials such as textiles, natural rubber, and leather that are found in the waste of urban areas. Currently, in the US, approximately 31% of organic waste is recovered from municipal solid waste via recycling and composting programs, 62% is deposited in landfills, and 7% is incinerated. Waste material can be converted into electricity by combustion boilers or steam turbines.

Note that like any fuel, biomass creates some pollutants, including carbon dioxide, when burned or converted into energy. In terms of air pollutants, biomass generate less relative to fossil fuels. Biomass is naturally low in sulphur and therefore, when burned, generates low sulphur dioxide emissions. However, if burned in the open air, some biomass feedstocks would emit relatively high levels of nitrous oxides (given the

high nitrogen content of plant material), carbon monoxide, and particulates.

Biogas: Biogas is produced from plant material and animal waste, garbage, waste from households and some types of industrial wastes, such as fish processing, dairies, and sewage treatment plants. It is a mixture of gases which includes methane, carbon dioxide, hydrogen sulphide and water vapour. In this mixture, methane burns easily. With a ton of food waste, one can produce 85 Cu. M of biogas. Once used, the residue is used as an agricultural fertilizer.

Denmark produces a large quantity of biogas from waste and produces 15,000 megawatts of electricity from 15 farmers' cooperatives. London has a plant which makes 30 megawatts of electricity a year from 420,000 tons of municipal waste which gives power to 50,000 families. In Germany, 25% of landfills for garbage produce power from biogas. Japan uses 85% of its waste and France about 50%.

Biogas plants have become increasingly popular in India in the rural sector. The biogas plants use cowdung, which is converted into a gas which is used as a fuel. It is also used for running dual fuel engines. The reduction in kitchen smoke by using biogas has reduced lung conditions in thousands of homes.

The fibrous waste of the sugar industry is the world's largest potential source of biomass energy. Ethanol produced from sugarcane molasses is a good automobile fuel and is now used in a third of the vehicles in Brazil.

The National Project on Biogas Development (NPBD), and Community/ Institutional Biogas Plant Program promote various biogas projects. By 1996 there were already 2.18 million families in India that used biogas. However China has 20 million households using biogas!

Activity 5:

What you may throw out in your garbage today could be used as fuel for someone else. Municipal solid waste has the potential to be a large energy source. Garbage is an inexpensive energy resource. Unlike most other energy resources, someone will collect garbage, deliver it to the power plant, and even pay to get rid of it. This helps cover the cost of turning garbage into energy. Garbage is also a unique resource because we all contribute to it.

Keep a record of all the garbage that you and our family produce in a day. What proportion of it is in the form of biomass? Weigh this.

How long would it take you to gather enough waste biomass to make a tankful (0.85 cu.m.) of biogas? (Remember one ton of biomass produces 85 cu.m. of biogas)

Wind Power: Wind was the earliest energy source used for transportation by sailing ships. Some 2000 years ago, windmills were developed

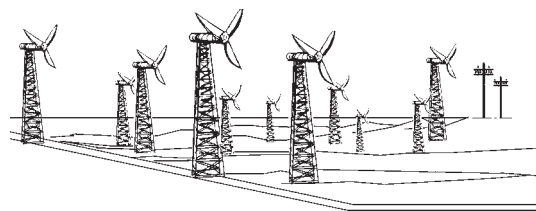

in China, Afghanistan and Persia to draw water for irrigation and grinding grain. Most of the early work on generating electricity from wind was carried out in Denmark, at the end of the last century. Today, Denmark and California have large wind turbine cooperatives which sell electricity to the government grid. In Tamil Nadu, there are large wind farms producing 850 megawatts of electricity. At present, India is the third largest wind energy producer in the world.

The power in wind is a function of the wind speed and therefore the average wind speed of an area is an important determinant of economically feasible power. Wind speed increases with height. At a given turbine site, the power available 30 meters above ground is typically 60 per cent greater than at 10 meters.

Over the past two decades, a great deal of technical progress has been made in the design, siting, installation, operation, and maintenance of power-producing wind mills (turbines). These improvements have led to higher wind conversion efficiencies and lower electricity production costs.

Environmental Impacts: Wind power has few environmental impacts, as there are virtually no air or water emissions, or radiation, or solid waste production. The principal problems are bird kills, noise, effect on TV reception, and aesthetic objections to the sheer number of wind turbines that are required to meet electricity needs.

Although large areas of land are required for setting up wind farms, the amount used by the turbine bases, the foundations and the access roads is less than 1% of the total area covered by the wind farm. The rest of the area can also be used for agricultural purposes or for grazing.

Siting windmills offshore reduces their demand for land and visual impact.

Wind is an intermittent source and the intermittency of wind depends on the geographic distribution of wind. Wind therefore cannot be used as the sole resource for

electricity, and requires some other backup or stand-by electricity source.

Tidal and Wave Power: The earth's surface is 70% water. By warming the water, the sun, creates ocean currents and wind that produces waves. It is estimated that the solar energy absorbed by the tropical oceans in a week could equal the entire oil reserves of the world – 1 trillion barrels of oil. The energy of waves in the sea that crash on the land of all the continents is estimated at 2 to 3 million megawatts of energy. From the 1970s several countries have been experimenting with technology to harness the kinetic energy of the ocean to generate electricity.

Tidal power is tapped by placing a barrage across an estuary and forcing the tidal flow to pass through turbines. In a one-way system the incoming tide is allowed to fill the basin through a sluice, and the water so collected is used to produce electricity during the low tide. In a two-way system power is generated from both the incoming as well as the outgoing tide.

WAVE POWER PLANT

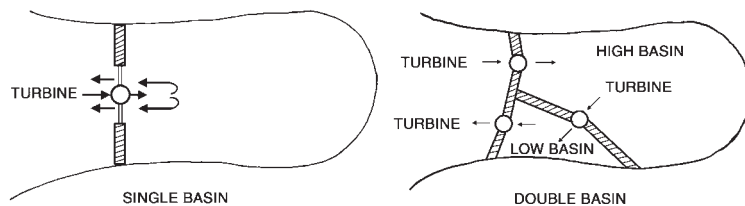
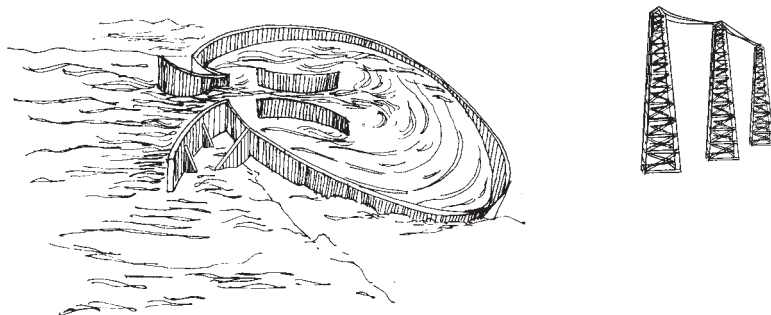

Natural Resources

Tidal power stations bring about major ecological changes in the sensitive ecosystem of coastal regions and can destroy the habitats and nesting places of water birds and interfere with fisheries. A tidal power station at the mouth of a river blocks the flow of polluted water into the sea, thereby creating health and pollution hazards in the estuary. Other drawbacks include offshore energy devices posing navigational hazards. Residual drift current could affect spawning of some fish, whose larvae would be carried away from spawning grounds. They may also affect the migration patterns of surface swimming fish.

Wave power converts the motion of waves into electrical or mechanical energy. For this, an energy extraction device is used to drive turbo-generators. Electricity can be generated at sea and transmitted by cable to land. This energy source has yet to be fully explored. The largest concentration of potential wave energy on earth is located between latitudes 40 to 60 degrees in both the northern and southern hemispheres, where the winds blow most strongly.

Another developing concept harnesses energy due to the differences in temperature between the warm upper layers of the ocean and the cold deep sea water. These plants are known as Ocean Thermal Energy Conversion (OTEC). This is a high tech installation which may prove to be highly valuable in the future.

Geothermal energy: is the energy stored within the earth ("geo" for earth and "thermal" for heat). Geothermal energy starts with hot, molten rock (called *magma*) deep inside the earth which surfaces at some parts of the earth's crust. The heat rising from the magma warms underground pools of water known as *geothermal reservoirs*. If there is an opening, hot underground water comes to the surface and forms hot springs, or it may boil to form geysers. With modern technology, wells are drilled

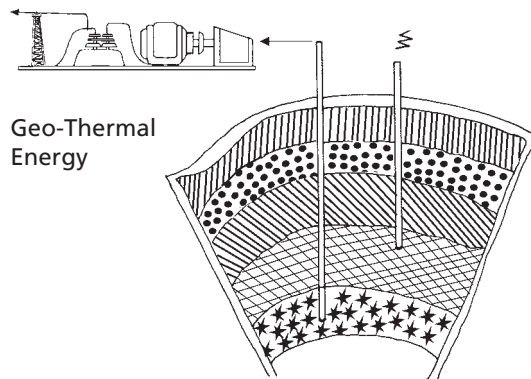

deep below the surface of the earth to tap into geothermal reservoirs. This is called *direct use* of geothermal energy, and it provides a steady stream of hot water that is pumped to the earth's surface.

In the 20th century geothermal energy has been harnessed on a large scale for space heating, industrial use and electricity production, especially in Iceland, Japan and New Zealand.

Geothermal energy is nearly as cheap as hydro-power and will thus be increasingly utilised in future. However, water from geothermal reservoirs often contains minerals that are corrosive and polluting. Geothermal fluids are a problem which must be treated before disposal.

Nuclear Power

In 1938 two German scientists Otto Hahn and Fritz Strassman demonstrated nuclear fission. They found they could split the nucleus of a uranium atom by bombarding it with neutrons. As the nucleus split, some mass was converted to energy. The nuclear power industry however was born in the late 1950s. The first large-scale nuclear power plant in the world became operational in 1957 in Pennsylvania, US.

Dr. Homi Bhabha was the father of Nuclear Power development in India. The Bhabha Atomic

Research Center in Mumbai studies and develops modern nuclear technology. India has 10 nuclear reactors at 5 nuclear power stations that produce 2% of India's electricity. These are located in Maharashtra (Tarapur), Rajasthan, Tamil Nadu, Uttar Pradesh and Gujrat. India has uranium from mines in Bihar. There are deposits of thorium in Kerala and Tamil Nadu.

The nuclear reactors use Uranium 235 to produce electricity. Energy released from 1kg of Uranium 235 is equivalent to that produced by burning 3,000 tons of coal. U235 is made into rods which are fitted into a nuclear reactor. The control rods absorb neutrons and thus adjust the fission which releases energy due to the chain reaction in a reactor unit. The heat energy produced in the reaction is used to heat water and produce steam, which drives turbines that produce electricity. The drawback is that the rods need to be changed periodically. This has impacts on the environment due to disposal of nuclear waste. The reaction releases very hot waste water that damages aquatic ecosystems, even though it is cooled by a water system before it is released.

The disposal of nuclear waste is becoming an increasingly serious issue. The cost of Nuclear Power generation must include the high cost of disposal of its waste and the decommissioning of old plants. These have high economic as well as ecological costs that are not taken into account when developing new nuclear installations. For environmental reasons, Sweden has decided to become a Nuclear Free Country by 2010.

Although the conventional environmental impacts from nuclear power are negligible, what overshadows all the other types of energy sources is that an accident can be devastating and the effects last for long periods of time. While it does not pollute air or water routinely like oil or biomass, a single accident can kill thousands of people, make many others seriously ill,

and destroy an area for decades by its radioactivity which leads to death, cancer and genetic deformities. Land, water, vegetation are destroyed for long periods of time. Management, storage and disposal of radioactive wastes resulting from nuclear power generation are the biggest expenses of the nuclear power industry. There have been nuclear accidents at Chernobyl in USSR and at the Three Mile Island in USA. The radioactivity unleashed by such an accident can affect mankind for generations.

Energy Conservation: Conventional energy sources have a variety of impacts on nature and human society.

India needs to rapidly move into a policy to reduce energy needs and use cleaner energy production technologies. A shift to alternate energy use and renewable energy sources that are used judiciously and equitably would bring about environmentally friendly and sustainable lifestyles. India must reduce its dependency on imported oil. At present we are under-utilizing our natural gas resources. We could develop thousands of mini dams to generate electricity. India wastes great amounts of electricity during transmission. Fuel wood plantations need to be enhanced and management through Joint Forestry Management (JFM) has a great promise for the future.

Energy efficient cooking stoves or 'chulas' help the movement of air through it so that the wood is burnt more efficiently. They also have a chimney to prevent air pollution and thus reduce respiratory problems. While over 2 lakh improved chulas have been introduced throughout the country, the number in active use is unknown as most rural people find it to be unusable for several reasons. TERI in 1995 estimated that in India 95% of rural people and 60% of urban poor still depend on firewood, cattle dung and crop residue for cooking and other domestic purposes. Biomass can be converted into biogas

or liquid fuels ie. ethanol and methanol. Biogas digesters convert animal waste or agricultural residues into gas. This is 60% methane and 40% CO₂ generated by fermentation. The commonly used agri waste is dung of domestic animals and rice husk, coconut shells, straw or weeds. The material left after the gas is used acts as a fertilizer.

Small hydrogeneration units are environment-friendly. They do not displace people, destroy forests or wildlife habitats or kill aquatic and terrestrial biodiversity. They can be placed in several hill streams, on canals or rivers. The generation depends on flowing water due to gravity. However, this fails if the flow is seasonal.

It is easy to waste energy but cheaper to save it than generate it. We can conserve energy by preventing or reducing waste of energy and by using resources more efficiently. People waste energy because government subsidises it. If the real cost was levied, people would not be able to afford to waste it carelessly.

Industry and transport are the main growing users of energy in India. Industries that are known for generating pollution also waste the most energy. These include chemical industries, especially petrochemical units, iron and steel, textiles, paper, etc. Unplanned and inefficient public transport systems, especially in cities, waste large amount of energy. Using bicycles is an excellent method to reduce the use of energy. In agriculture, irrigation pumps to lift water are the most energy intensive agricultural use. These are either electrical or run on fossil fuels.

CASE STUDIES

Indian industries use more energy than necessary.

Steel and energy: To produce one tonne of steel, India spends 9.5 million kilocalories. In Italy it is 4.3 million kilocalories and for Japan it is only 4.1 million kilocalories.

Cement industry: Over 2 million kilocalories are used to produce one tonne of cement in India. In Germany it is 0.82 million kilocalories, in USA, 0.92 million kilocalories.

Vehicles: Lighter materials should be used for cars. Instead of steel we should use aluminum, fiber glass or plastics. These lighter materials can reduce the weight by 15 % and increase the fuel economy by 6 to 8%.

Refrigerators: Better technologies reduced the annual energy needed by a typical Danish 200 liter refrigerator (with no freezer) from 350 kilo Watt hour (kWh) to 90 kWh.

Lighting: An 18-watt modern, compact fluorescent lamp, can replace a standard 75-watt incandescent lamp.

f) Land resources:

Land as a resource: Landforms such as hills, valleys, plains, river basins and wetlands include different resource generating areas that the people living in them depend on. Many traditional farming societies had ways of preserving areas from which they used resources. Eg. In the 'sacred groves' of the Western Ghats, requests to the spirit of the Grove for permission to cut a tree, or extract a resource, were accompanied by simple rituals. The outcome of a chance fall on one side or the other of a stone

balanced on a rock gave or withheld permission. The request could not be repeated for a specified period.

If land is utilized carefully it can be considered a renewable resource.

The roots of trees and grasses bind the soil. If forests are depleted, or grasslands overgrazed, the land becomes unproductive and wasteland is formed. Intensive irrigation leads to water logging and salination, on which crops cannot grow. Land is also converted into a non-renewable resource when highly toxic industrial and nuclear wastes are dumped on it.

Land on earth is as finite as any of our other natural resources. While mankind has learnt to adapt his lifestyle to various ecosystems world over, he cannot live comfortably for instance on polar ice caps, on under the sea, or in space in the foreseeable future.

Man needs land for building homes, cultivating food, maintaining pastures for domestic animals, developing industries to provide goods, and supporting the industry by creating towns and cities. Equally importantly, man needs to protect wilderness area in forests, grasslands, wetlands, mountains, coasts, etc. to protect our vitally valuable biodiversity.

Thus a rational use of land needs careful planning. One can develop most of these different types of land uses almost anywhere, but Protected Areas (National Park's and Wildlife Sanctuaries) can only be situated where some of the natural ecosystems are still undisturbed. These Protected Areas are important aspects of good landuse planning.

Natural Resources

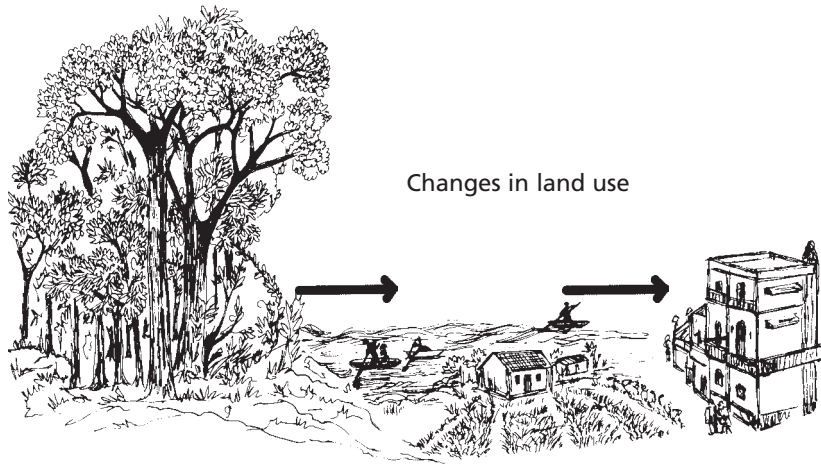

Land Degradation: Farmland is under threat due to more and more intense utilisation. Every year, between 5 to 7 million hectares of land worldwide is added to the existing degraded farmland. When soil is used more intensively by farming, it is eroded more rapidly by wind and rain. Over irrigating farmland leads to salinisation, as evaporation of water brings the salts to the surface of the soil on which crops cannot grow. Over irrigation also creates water logging of the topsoil so that crop roots are affected and the crop deteriorates. The use of more and more chemical fertilizers poisons the soil so that eventually the land becomes unproductive.

As urban centers grow and industrial expansion occurs, the agricultural land and forests shrink. This is a serious loss and has long term ill effects on human civilisation.

Soil erosion: The characteristics of natural ecosystems such as forests and grasslands depend on the type of soil. Soils of various types support a wide variety of crops. The misuse of an ecosystem leads to loss of valuable soil through erosion by the monsoon rains and, to a smaller extent, by wind. The roots of the trees in the forest hold the soil. Deforestation thus leads to

rapid soil erosion. Soil is washed into streams and is transported into rivers and finally lost to the sea. The process is more evident in areas where deforestation has led to erosion on steep hill slopes as in the Himalayas and in the Western Ghats. These areas are called 'ecologically sensitive areas' or ESAs. To prevent the loss of millions of tons of valuable soil every year, it is essential to preserve what remains of our natural forest cover. It is equally important to reforest denuded areas. The linkage between the existence of forests and the presence of soil is greater than the forest's physical soil binding

CASE STUDY

Selenium – Punjab

In 1981-82, farmers from Hoshirapur and Nawanshehar Districts approached scientists of the Punjab Agricultural University (PAU), Ludhiana, as wheat crops had turned white. Soil analysis indicated selenium (Se) levels in the area were above toxic limits. Se is a naturally occurring trace element, essential for animal and human health, but the gap between requirement and excess is narrow. Soils containing 0.5 microgrammes (ug) of Se per kg or more are injurious to health. In some areas of Punjab, Se levels range from 0.31 ug/kg to 4.55ug/kg. Rice cultivation requires the presence of standing water. Being highly soluble, Se dissolves and comes to the surface. The water then evaporates leaving the Se behind.

function alone. The soil is enriched by the leaf-litter of the forest. This detritus is broken down by soil micro-organisms, fungi, worms and insects, which help to recycle nutrients in the system. Further losses of our soil wealth will impoverish our country and reduce its capacity to grow enough food in future.

2.3 ROLE OF AN INDIVIDUAL IN CONSERVATION OF NATURAL RESOURCES

Until fairly recently mankind acted as if he could go on for ever exploiting the ecosystems and natural resources such as soil, water, forests and grasslands on the Earth's surface and extracting minerals and fossil fuels from underground. But, in the last few decades, it has become increasingly evident that the global ecosystem has the capacity to sustain only a limited level of utilization. Biological systems cannot go on replenishing resources if they are overused or misused. At a critical point, increasing pressure destabilizes their natural balance. Even biological resources traditionally classified as 'renewable' - such as those from our oceans, forests, grasslands and wetlands, are being degraded by overuse and may be permanently destroyed. And no natural resource is limitless. 'Non-renewable' resources will be rapidly exhausted if we continue to use them as intensively as at present.

The two most damaging factors leading to the current rapid depletion of all forms of natural resources are increasing 'consumerism' on the part of the affluent sections of society, and rapid population growth. Both factors are the results of choices *we make as individuals*. As individuals we need to decide;

- What will we leave to our children? (Are we thinking of short-term or long-term gain?)
- Is my material gain someone else's loss?

Greed for material goods has become a way of life for a majority of people in the developed world. Population growth and the resulting shortage of resources most severely affects people in the developing countries. In nations such as ours, which are both developing rapidly, and suffering from a population explosion, both factors are responsible for environmental degradation. We must ask ourselves if we have

perhaps reached a critical flash point, at which economic 'development' affects the lives of people more adversely than the benefits it provides.

What can you do to save electricity?

- Turn off lights and fans as soon as you leave the room.
- Use tube lights and energy efficient bulbs that save energy rather than bulbs. A 40-watt tube light gives as much light as a 100 watt bulb.
- Keep the bulbs and tubes clean. Dust on tubes and bulbs decreases lighting levels by 20 to 30 percent.
- Switch off the television or radio as soon as the program of interest is over.
- A pressure cooker can save up to 75 percent of energy required for cooking. It is also faster.
- Keeping the vessel covered with a lid during cooking, helps to cook faster, thus saving energy.

2.4 EQUITABLE USE OF RESOURCES FOR SUSTAINABLE LIFESTYLES

Reduction of the unsustainable and unequal use of resources, and control of our population growth are essential for the survival of our nation and indeed of human kind everywhere. Our environment provides us with a variety of goods and services necessary for our day-to-day lives, but the soil, water, climate and solar energy which form the 'abiotic' support that we derive from nature, are in themselves not distributed evenly throughout the world or within countries. A new economic order at the global and at na-

tional levels must be based on the ability to distribute benefits of natural resources by sharing them more equally among the countries as well as among communities within countries such as our own. It is at the local level where people subsist by the sale of locally collected resources, that the disparity is greatest. 'Development' has not reached them and they are often unjustly accused of 'exploiting' natural resources. They must be adequately compensated for the removal of the sources to distant regions and thus develop a greater stake in protecting natural resources.

There are several principles that each of us can adopt to bring about sustainable lifestyles. This primarily comes from caring for our Mother Earth in all respects. A love and respect for Nature is the greatest sentiment that helps bring about a feeling for looking at how we use natural resources in a new and sensitive way. Think of the beauty of a wilderness, a natural forest in all its magnificence, the expanse of a green grassland, the clean water of a lake that supports so much life, the crystal clear water of a hill stream, or the magnificent power of the oceans, and we cannot help but support the conservation of nature's wealth. If we respect this we cannot commit acts that will deplete our life supporting systems.